

Name	VS44_0362 400x400/44		
Zeichnung/Drawing	3D	VS44_0362	
Profil/Profile	4.4x13.5	Maßstab/Scale	1:30
		Druck auf/ Print on	A3
		Datum/Date	28.04.2026

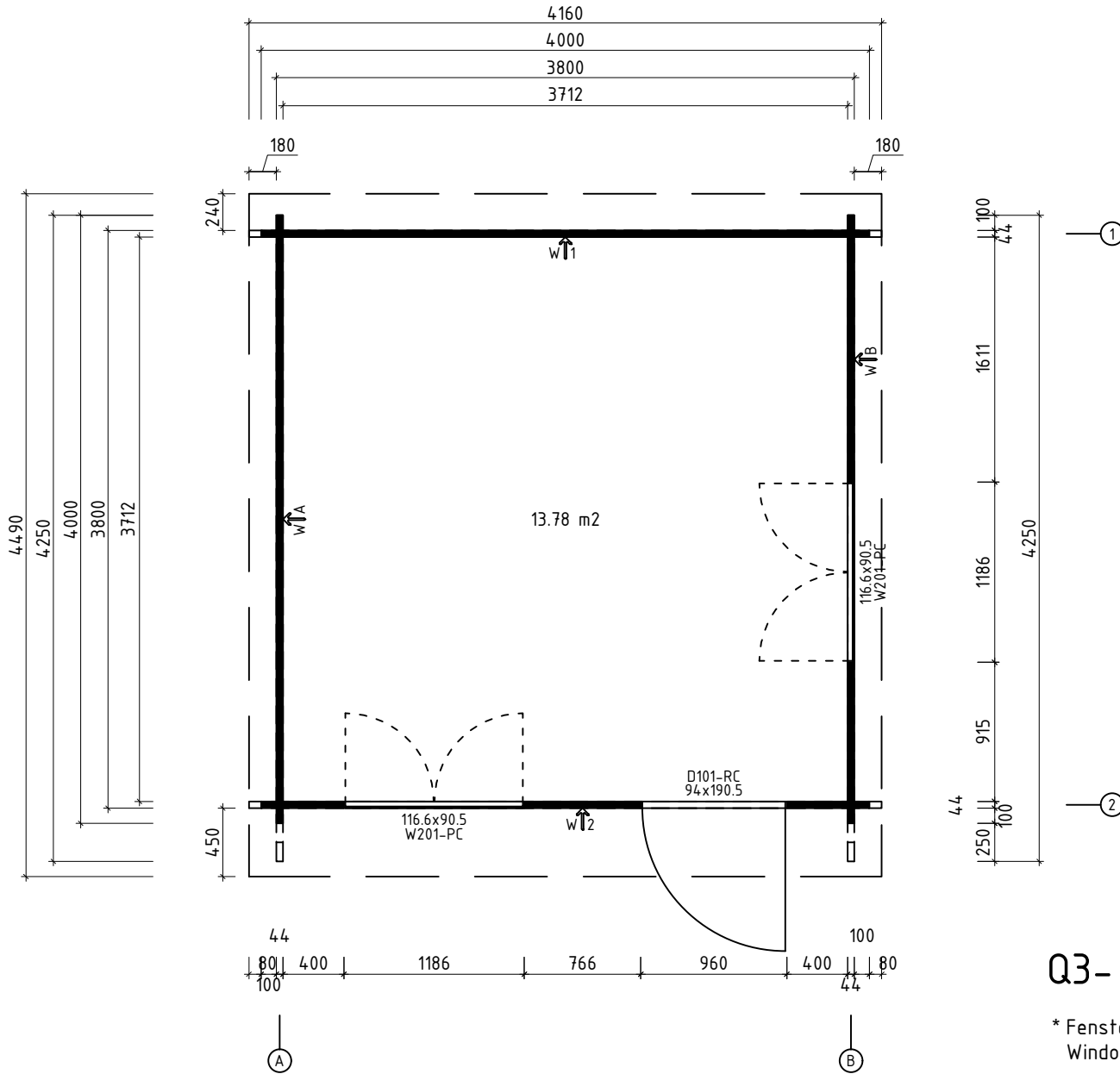







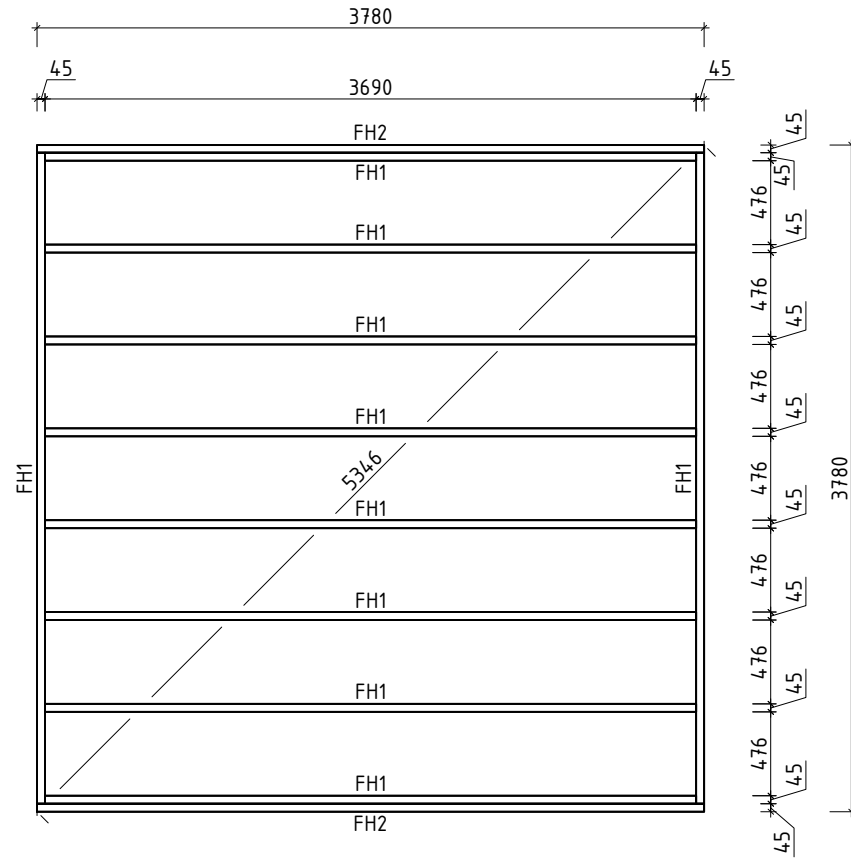

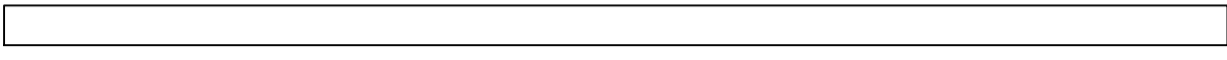
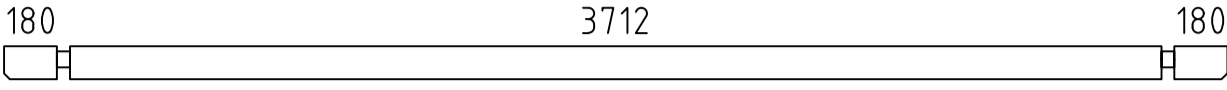
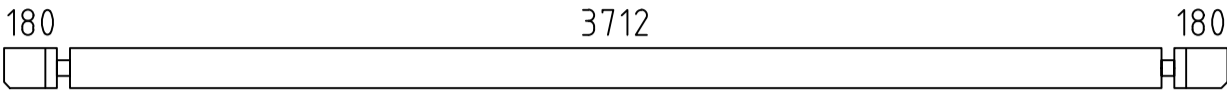
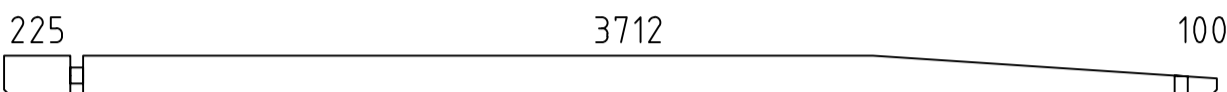
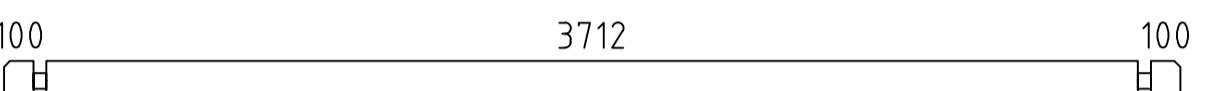
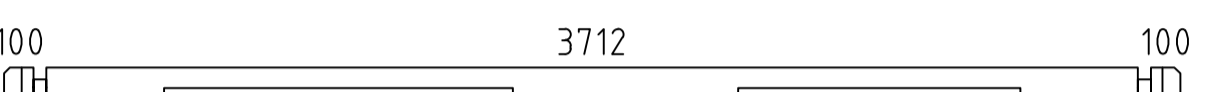
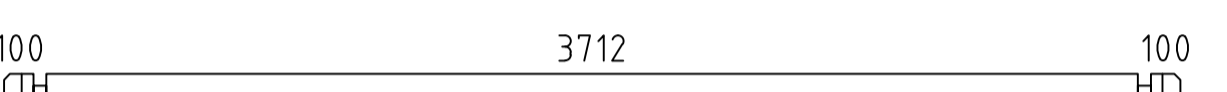
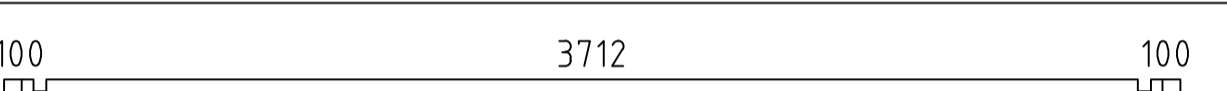
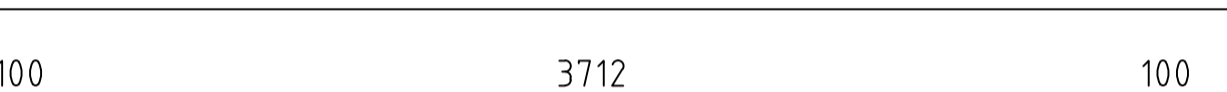
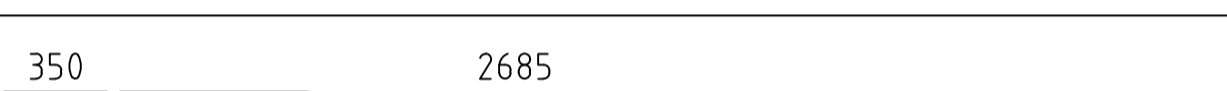

**Q3-** Qualitätsklasse für Fenster und Türen/  
Quality class for windows and doors

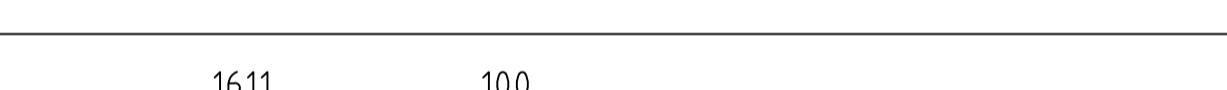
\* Fenster und Türen sind mit Sprossen/  
Windows and doors are with muntins

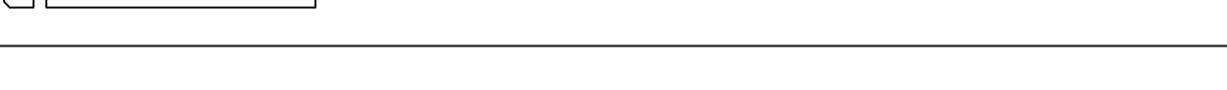
Name	VS44_0362 400x400/44		
Zeichnung/Drawing	Grundplan; Plan	VS44_0362	
Profil/Profile	4.4x13.5	Maßstab/Scale	1:30
		Druck auf/ Print on	A3
		Datum/Date	28.04.2026

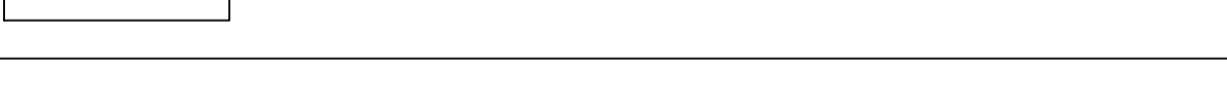
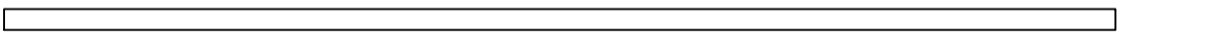
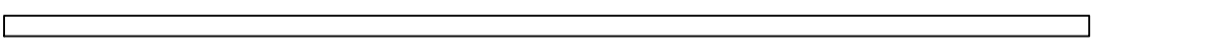
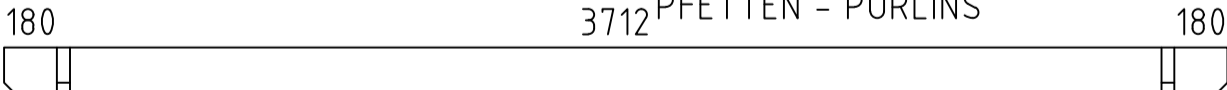
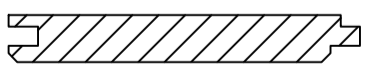
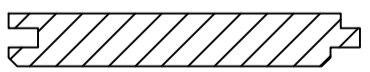

Name VS44_0362 400x400/44			
Zeichnung/Drawing Lagerholzplan; Foundation beams		VS44_0362	
Profil/Profile 4.4x13.5	Maßstab/Scale 1:30	Druck auf/Print on A3	Datum/Date 28.04.2026

Pos	Teileliste/Specification VS44_0362 400x400/44		Pcs.	Profile (mm)	Length (mm)
	<u>Achtung!</u> Die Giebelbohlen können teilweise schon vormontiert sein! Bitte beachten - diese erscheinen nicht ganz so wie in der Teileliste beschrieben.				
	<u>Notice!</u> The gable pieces can be partly pre-assembled! Please notice - those differ from the description given in the specification list.				
1extra			1	44x135	4160
001			1	44x112	4160
002			1	44x135	4160
003			2	44x135	4125
004			23	44x135	4000
005			1	44x135	4000
006			16	44x135	4000
007			1	44x135	4000
008			2	44x68	4000
009			2	44x135	3080
010			1	44x135	2496
011			7	44x135	2496
012			7	44x135	1755
013			7	44x135	1059
014			2	44x68	1027
015			6	44x135	766
016			20	44x135	544
FH2	FUNDAMENTHOLZ (imprägniert) - FOUNDATION BEAM (impregnated) 		2	45x70	3780
FH1	FUNDAMENTHOLZ (imprägniert) - FOUNDATION BEAM (impregnated) 		10	45x70	3690
PF1	180 3712 PFETTEN - PURLINS 180 		4	58x170	4160
	DACHBRETTER - ROOF BOARDS 		37+1	113x16	4500
	FUSSBODENBRETTER - FLOOR BOARDS 		33+1	113x18	3707
	FUSSBODENLEISTEN - FLOOR STRIPS  ✓			18x40	17,0 lfm/rm
G02-1	GIEBELBRETTER - GABLE BOARDS 18x120 3,8°  ✓		2	18x120	4520
G05-1	GIEBELDECKLEISTEN - GABLE COVER STRIPS 18x40  ✓		2	18x40	4500
Kood	VS44_0362 400x400/44		Materjal		Leht 1/4







## Vihmaliist / Rain strip / Wasserleiste

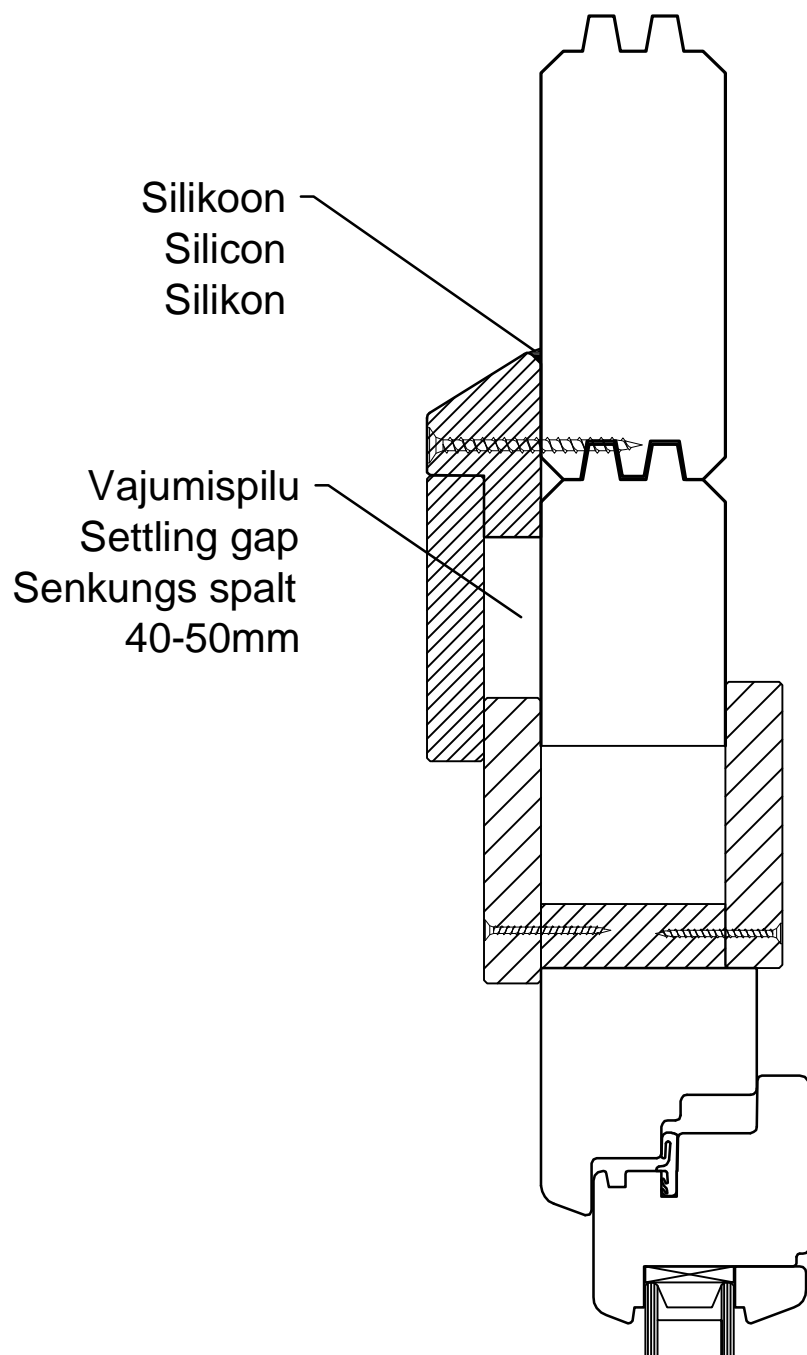

NB!

- Monteerida juhul kui ese on välja toodud maja spetsifikatsioonis!
- Install only if the item is listed in the house specification!
- Nur montieren wenn die Leiste in der Teileliste gezeigt ist!

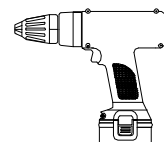

Aken	Q4-Q6	-	paigaldusjuhis
Window	Q4-Q6	-	assembly instructions
Fenster	Q4-Q6	-	Montageanleitung

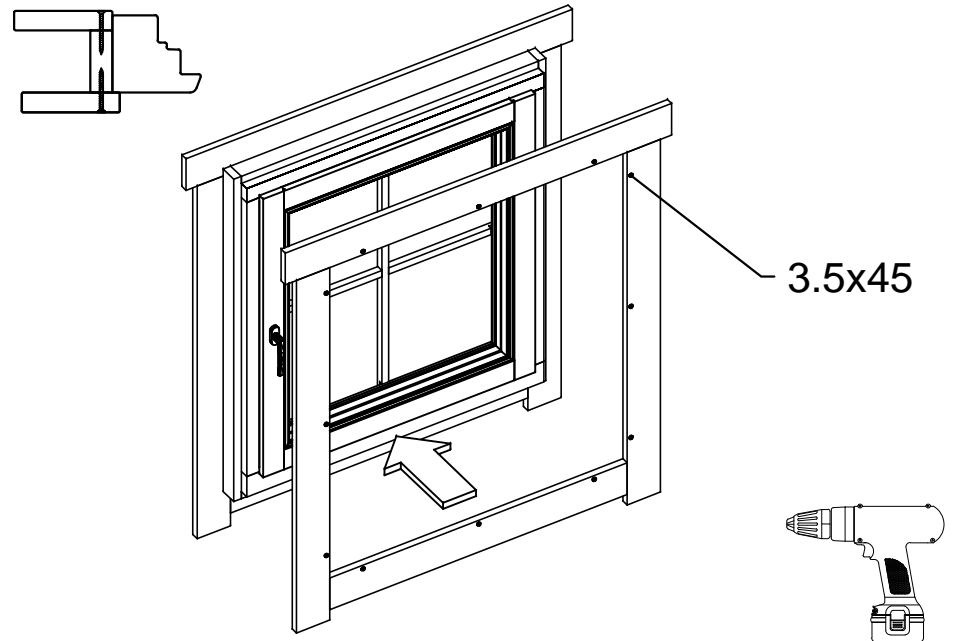
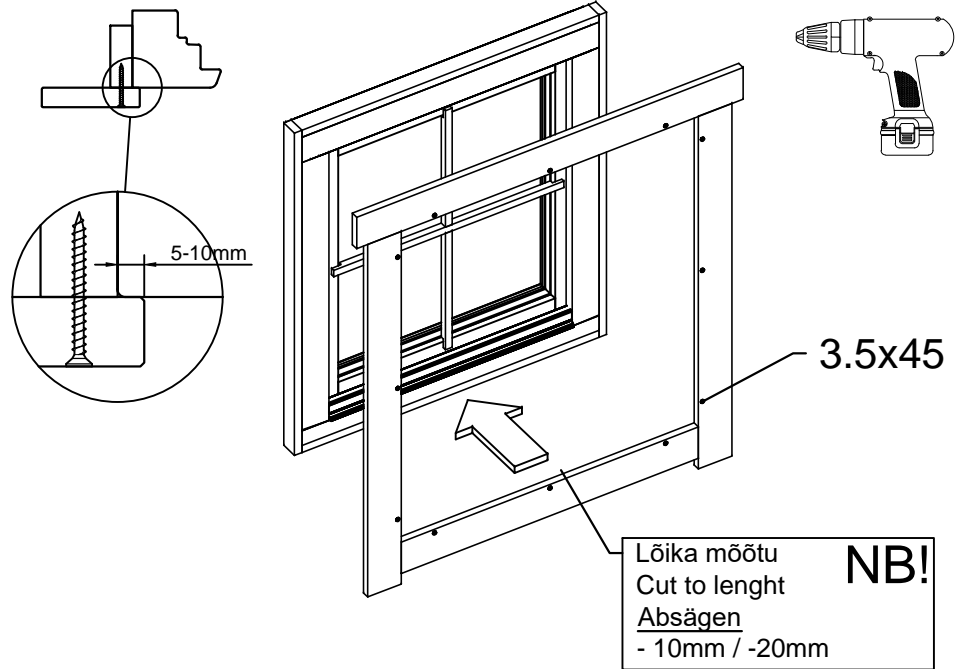
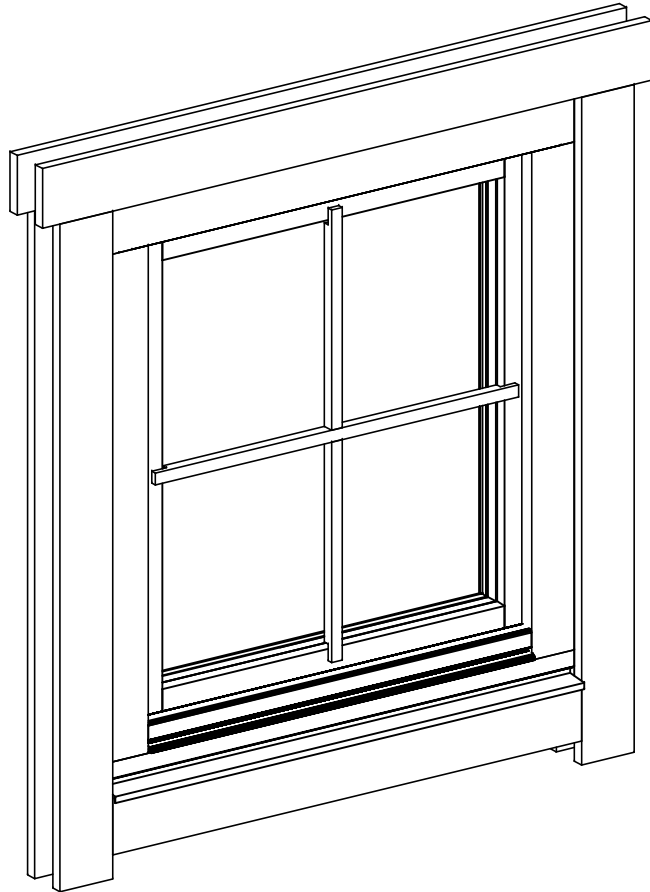

- Taufendeckleisten
- Eaves cover strips
- Dachbretter
- Roof boards
- Traufenleisten
- Eaves strips
- Traufenbretter
- Eaves boards

- Dachbretter
- Roof boards
- Traufenbretter
- Gable boards
- Traufenleisten
- Eaves strips

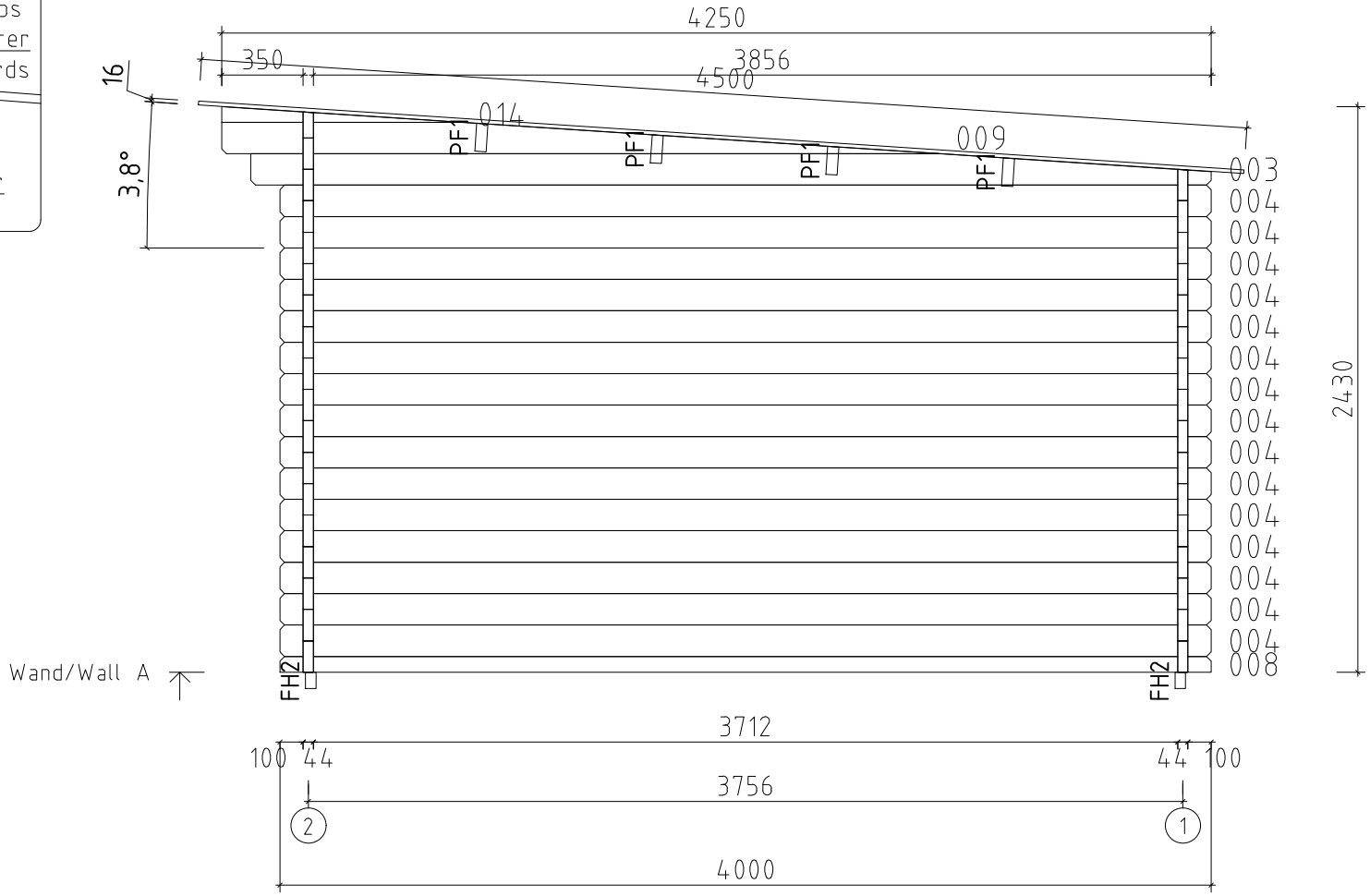

Wand/Wall A ↑

Name VS44_0362 400x400/44			
Zeichnung/Drawing WAND/WALL A		VS44_0362	
Profil/Profile 4.4x13.5	Maßstab/Scale 1:30	Druck auf/Print on A4	Datum/Date 28.04.2026

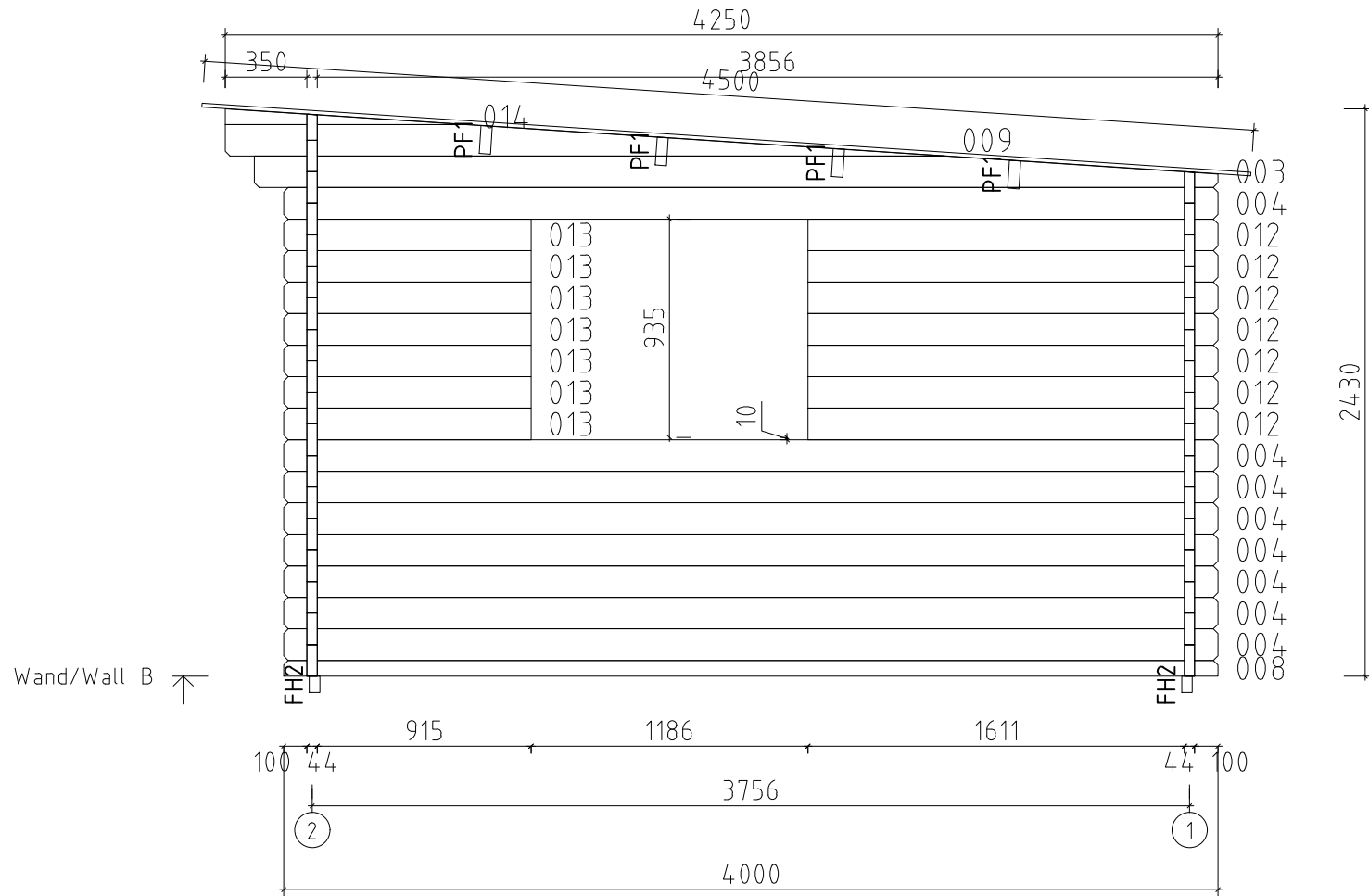

Name				VS44_0362 400x400/44			
Zeichnung/Drawing		WAND/WALL B		VS44_0362			
Profil/Profile		4.4x13.5		Maßstab/Scale		1:30	
				Druck auf/Print on		A4	
				Datum/Date		28.04.2026	

- Giebeldeckleisten
- Gable cover strips
- Dachbretter
- Roof boards 16x113
- Giebelbretter
- Gable boards
- Pfetten/Wandbohlen
- Purlins/Wall log

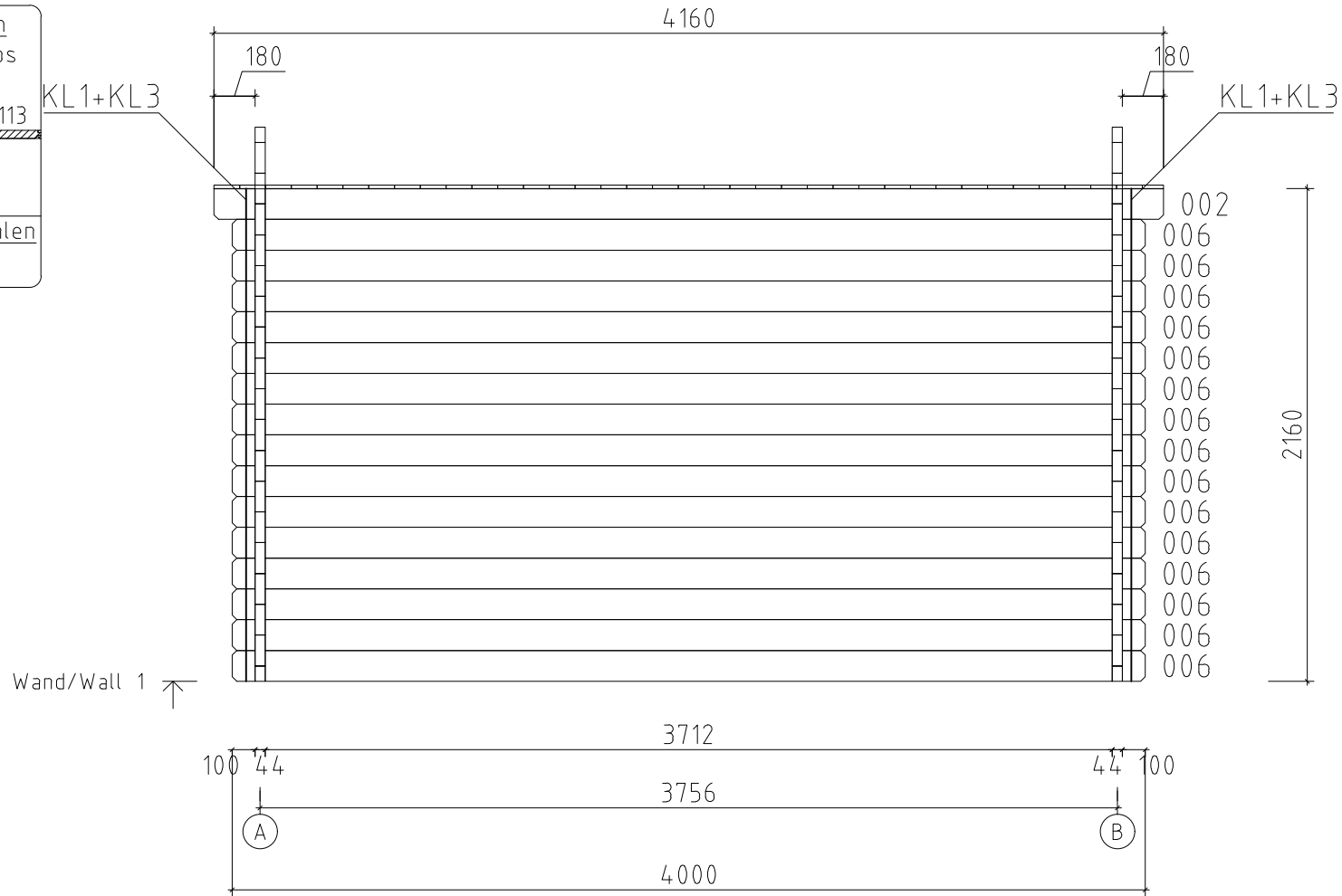

Name VS44_0362 400x400/44			
Zeichnung/Drawing WAND/WALL 1		VS44_0362	
Profil/Profile 4.4x13.5	Maßstab/Scale 1:30	Druck auf/Print on A4	Datum/Date 28.04.2026

